

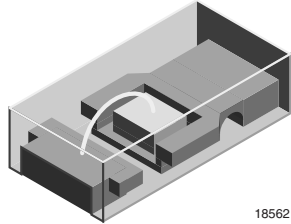

Standard 0603 SMD LED



18562

DESCRIPTION

The new 0603 LED series have been designed in the smallest SMD package. This innovative 0603 LED technology opens the way to

- smaller products of higher performance
- more design in flexibility
- enhanced applications

The 0603 LED is an obvious solution for small-scale, high power products that are expected to work reliability in an arduous environment.

PRODUCT GROUP AND PACKAGE DATA

- Product group: LED
- Package: SMD 0603
- Product series: standard
- Angle of half intensity: $\pm 80^\circ$

FEATURES

- Smallest SMD package 0603 with exceptional brightness 1.6 mm x 0.8 mm x 0.6 mm (L x W x H)
- High reliability lead frame based
- Temperature range - 40 °C to + 100 °C
- Footprint compatible to 0603 chipled
- Wavelength 470 nm (blue), 570 nm (green), 560 nm (pure green), 587 nm (yellow), 606 nm (orange), 633 nm (red)
- AlInGaP and GaN technology
- Viewing angle: extremely wide 160°
- Grouping parameter: luminous intensity, wavelength
- Available in 8 mm tape
- Compatible to IR reflow soldering
- Lead (Pb)-free device
- Component in accordance to RoHS 2002/95/EC and WEEE 2002/96/EC
- Preconditioning: acc. to JEDEC level 2
- Automotive qualified AEC-Q101



APPLICATIONS

- Backlight keypads
- Navigation systems
- Cellular phone displays
- Displays for industrial control systems
- Automotive features
- Miniaturized color effects
- Traffic displays

PARTS TABLE	
PART	COLOR, LUMINOUS INTENSITY AT $I_F = 20 \text{ mA}$
TLMS1100-GS08	Red, $I_V = 63 \text{ mcd (typ.)}$
TLMO1100-GS08	Orange, $I_V = 80 \text{ mcd (typ.)}$
TLMY1100-GS08	Yellow, $I_V = 80 \text{ mcd (typ.)}$
TLMG1100-GS08	Green, $I_V = 35 \text{ mcd (typ.)}$
TLMP1100-GS08	Pure green, $I_V = 15 \text{ mcd (typ.)}$
TLMB1100-GS08	Blue, $I_V = 5 \text{ mcd (typ.)}$



ABSOLUTE MAXIMUM RATINGS ¹⁾ TLMS1100, TLM01100, TLMY1100, TLMG1100, TLMP1100				
PARAMETER	TEST CONDITION	SYMBOL	VALUE	UNIT
Reverse voltage ²⁾		V_R	12	V
DC Forward current	$T_{amb} \leq 75\text{ }^\circ\text{C}$	I_F	30	mA
Surge forward current	$t_p \leq 10\text{ }\mu\text{s}$	I_{FSM}	0.5	A
Power dissipation		P_V	90	mW
Junction temperature		T_j	120	$^\circ\text{C}$
Operating temperature range		T_{amb}	- 40 to + 100	$^\circ\text{C}$
Storage temperature range		T_{stg}	- 40 to + 100	$^\circ\text{C}$
Soldering temperature	acc. Vishay spec.	T_{sd}	260	$^\circ\text{C}$
Thermal resistance junction/ambient	mounted on PC board (pad size > 5 mm ²)	R_{thJA}	480	K/W

Note:

- 1) $T_{amb} = 25\text{ }^\circ\text{C}$, unless otherwise specified
- 2) Driving the LED in reverse direction is suitable for short term application

ABSOLUTE MAXIMUM RATINGS ¹⁾ TLMB1100				
PARAMETER	TEST CONDITION	SYMBOL	VALUE	UNIT
Reverse voltage ²⁾		V_R	5	V
DC Forward current	$T_{amb} \leq 60\text{ }^\circ\text{C}$	I_F	15	mA
Surge forward current	$t_p \leq 10\text{ }\mu\text{s}$	I_{FSM}	0.1	A
Power dissipation		P_V	68	mW
Junction temperature		T_j	100	$^\circ\text{C}$
Operating temperature range		T_{amb}	- 40 to + 100	$^\circ\text{C}$
Storage temperature range		T_{stg}	- 40 to + 100	$^\circ\text{C}$
Soldering temperature	acc. Vishay spec.	T_{sd}	260	$^\circ\text{C}$
Thermal resistance junction/ambient	mounted on PC board (pad size > 5 mm ²)	R_{thJA}	480	K/W

Note:

- 1) $T_{amb} = 25\text{ }^\circ\text{C}$, unless otherwise specified
- 2) Driving the LED in reverse direction is suitable for short term application

OPTICAL AND ELECTRICAL CHARACTERISTICS ¹⁾ TLMS1100, RED						
PARAMETER	TEST CONDITION	SYMBOL	MIN.	TYP.	MAX.	UNIT
Luminous intensity	$I_F = 20\text{ mA}$	I_V	32	63		mcd
Dominant wavelength	$I_F = 20\text{ mA}$	λ_d	627	633	639	nm
Peak wavelength	$I_F = 20\text{ mA}$	λ_p		645		nm
Angle of half intensity	$I_F = 20\text{ mA}$	ϕ		± 80		deg
Forward voltage	$I_F = 20\text{ mA}$	V_F		2.1	3.0	V
Reverse voltage	$I_R = 10\text{ }\mu\text{A}$	V_R	6			V
Junction capacitance	$V_R = 0, f = 1\text{ MHz}$	C_j		15		pF

Note:

- 1) $T_{amb} = 25\text{ }^\circ\text{C}$, unless otherwise specified



OPTICAL AND ELECTRICAL CHARACTERISTICS ¹⁾ TLMO1100, ORANGE						
PARAMETER	TEST CONDITION	SYMBOL	MIN.	TYP.	MAX.	UNIT
Luminous intensity	$I_F = 20 \text{ mA}$	I_V	50	80		mcd
Dominant wavelength	$I_F = 20 \text{ mA}$	λ_d	600	606	609	nm
Peak wavelength	$I_F = 20 \text{ mA}$	λ_p		610		nm
Angle of half intensity	$I_F = 20 \text{ mA}$	φ		± 80		deg
Forward voltage	$I_F = 20 \text{ mA}$	V_F		2.1	3	V
Reverse voltage	$I_R = 10 \mu\text{A}$	V_R	6			V
Junction capacitance	$V_R = 0, f = 1 \text{ MHz}$	C_j		15		pF

Note:

1) $T_{amb} = 25 \text{ }^\circ\text{C}$, unless otherwise specified

OPTICAL AND ELECTRICAL CHARACTERISTICS ¹⁾ TLMY1100, YELLOW						
PARAMETER	TEST CONDITION	SYMBOL	MIN.	TYP.	MAX.	UNIT
Luminous intensity	$I_F = 20 \text{ mA}$	I_V	50	80		mcd
Dominant wavelength	$I_F = 20 \text{ mA}$	λ_d	580	587	595	nm
Peak wavelength	$I_F = 20 \text{ mA}$	λ_p		591		nm
Angle of half intensity	$I_F = 20 \text{ mA}$	φ		± 80		deg
Forward voltage	$I_F = 20 \text{ mA}$	V_F		2.1	3	V
Reverse voltage	$I_R = 10 \mu\text{A}$	V_R	6			V
Junction capacitance	$V_R = 0, f = 1 \text{ MHz}$	C_j		15		pF

Note:

1) $T_{amb} = 25 \text{ }^\circ\text{C}$, unless otherwise specified

OPTICAL AND ELECTRICAL CHARACTERISTICS ¹⁾ TLMG1100, GREEN						
PARAMETER	TEST CONDITION	SYMBOL	MIN.	TYP.	MAX.	UNIT
Luminous intensity	$I_F = 20 \text{ mA}$	I_V	12.5	35		mcd
Dominant wavelength	$I_F = 20 \text{ mA}$	λ_d	564	570	575	nm
Peak wavelength	$I_F = 20 \text{ mA}$	λ_p		572		nm
Angle of half intensity	$I_F = 20 \text{ mA}$	φ		± 80		deg
Forward voltage	$I_F = 20 \text{ mA}$	V_F		2.1	3.0	V
Reverse voltage	$I_R = 10 \mu\text{A}$	V_R	6			V
Junction capacitance	$V_R = 0, f = 1 \text{ MHz}$	C_j		15		pF

Note:

1) $T_{amb} = 25 \text{ }^\circ\text{C}$, unless otherwise specified

OPTICAL AND ELECTRICAL CHARACTERISTICS ¹⁾ TLMP1100, PURE GREEN						
PARAMETER	TEST CONDITION	SYMBOL	MIN.	TYP.	MAX.	UNIT
Luminous intensity	$I_F = 20 \text{ mA}$	I_V	6.3	15		mcd
Dominant wavelength	$I_F = 20 \text{ mA}$	λ_d	551	558	566	nm
Peak wavelength	$I_F = 20 \text{ mA}$	λ_p		555		nm
Angle of half intensity	$I_F = 20 \text{ mA}$	φ		± 80		deg
Forward voltage	$I_F = 20 \text{ mA}$	V_F		2.1	3	V
Reverse voltage	$I_R = 10 \mu\text{A}$	V_R	6			V
Junction capacitance	$V_R = 0, f = 1 \text{ MHz}$	C_j		15		pF

Note:

1) $T_{amb} = 25 \text{ }^\circ\text{C}$, unless otherwise specified



OPTICAL AND ELECTRICAL CHARACTERISTICS ¹⁾ TLMB1100, BLUE						
PARAMETER	TEST CONDITION	SYMBOL	MIN	TYP.	MAX	UNIT
Luminous intensity	$I_F = 10 \text{ mA}$	I_V	4	5		mcd
Dominant wavelength	$I_F = 10 \text{ mA}$	λ_d		466		nm
Peak wavelength	$I_F = 10 \text{ mA}$	λ_p		428		nm
Angle of half intensity	$I_F = 10 \text{ mA}$	φ		± 80		deg
Forward voltage	$I_F = 20 \text{ mA}$	V_F		3.9	4.5	V
Reverse voltage	$I_R = 10 \mu\text{A}$	V_R	5.0			V

Note:

1) $T_{amb} = 25 \text{ }^\circ\text{C}$, unless otherwise specified

COLOR CLASSIFICATION										
GROUP	DOMINANT WAVELENGTH (nm)									
	BLUE		PURE GREEN		GREEN		YELLOW		ORANGE	
	MIN.	MAX.	MIN.	MAX.	MIN.	MAX.	MIN.	MAX.	MIN.	MAX.
- 1			551	554	564	565				
- 2	460	464	554	557	566	569	580	583	600	603
- 3	464	468	557	560	569	572	583	586	603	606
- 4	468	472	560	563	572	575	586	589	606	609
- 5	472	476	563	566			589	592	609	612
- 6							592	595		

Note:

Wavelengths are tested at a current pulse duration of 25 ms and an accuracy of $\pm 1 \text{ nm}$

LUMINOUS INTENSITY CLASSIFICATION		
GROUP	LUMINOUS INTENSITY (mcd)	
	MIN.	MAX.
Pa	4	6.3
Pb	5	8
Qa	6.3	10
Qb	8	12.5
Ra	10	16
Rb	12.5	20
Sa	16	25
Sb	20	32
Ta	25	40
Tb	32	50
Ua	40	63
Ub	50	80
Va	63	100
Vb	80	125
Wa	100	160
Wb	125	200

Note:

Luminous intensity is tested at a current pulse duration of 25 ms and an accuracy of $\pm 11 \%$.

The above type numbers represent the order groups which include only a few brightness groups. Only one group will be shipped on each reel (there will be no mixing of two groups on each reel).

In order to ensure availability, single brightness groups will not be orderable.

In a similar manner for colors where wavelength groups are measured and binned, single wavelength groups will be shipped in any one reel.

In order to ensure availability, single wavelength groups will not be orderable.



GROUP NAME ON LABEL		
LUMINOUS INTENSITY GROUP	HALFGROUP	WAVELENGTH
Q	b	4

Note:

One packing unit/tape contains only one classification group of luminous intensity, color and forward voltage.

Only one single classification groups is not available.

The given groups are not order codes, customer specific group combinations require marketing agreement.

No color subgrouping for super red.

TYPICAL CHARACTERISTICS

T_{amb} = 25 °C, unless otherwise specified

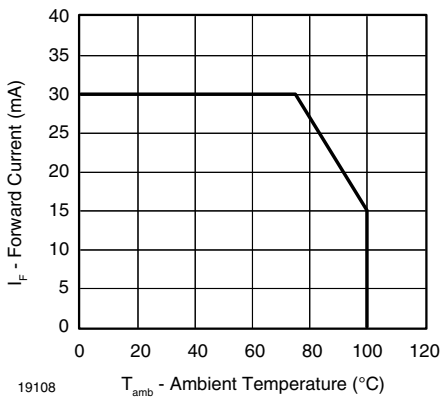

Figure 1. Forward Current vs. Ambient Temperature

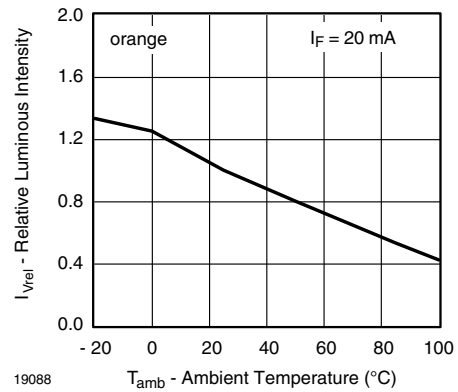

Figure 3. Relative Luminous Intensity vs. Amb. Temperature

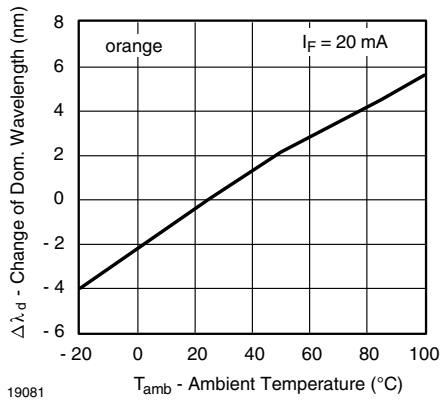

Figure 2. Change of Dominant Wavelength vs. Ambient Temperature

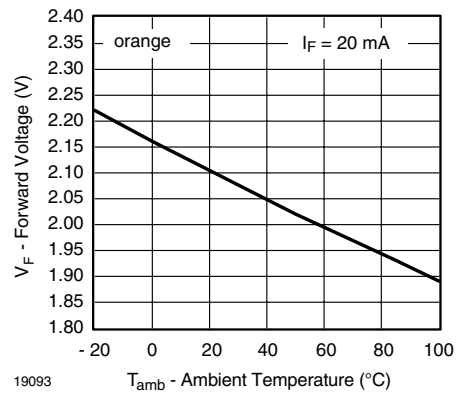

Figure 4. Forward Voltage vs. Ambient Temperature

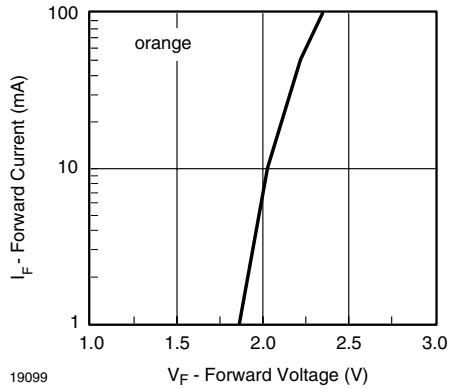

Figure 5. Forward Current vs. Forward Voltage

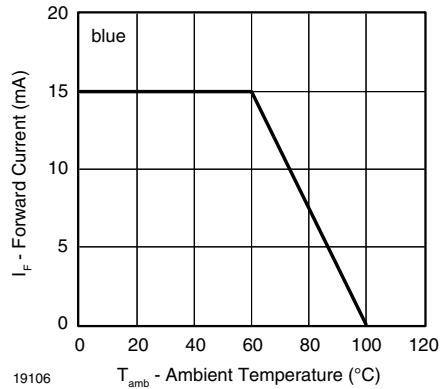

Figure 8. Forward Current vs. Ambient Temperature

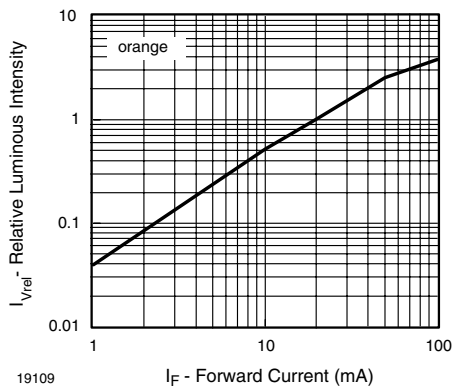

Figure 6. Relative Luminous Intensity vs. Forward Current

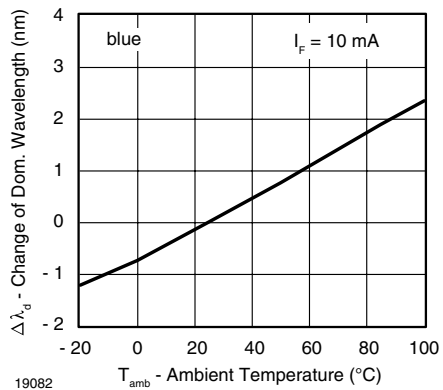

Figure 9. Change of Dominant Wavelength vs. Ambient Temperature

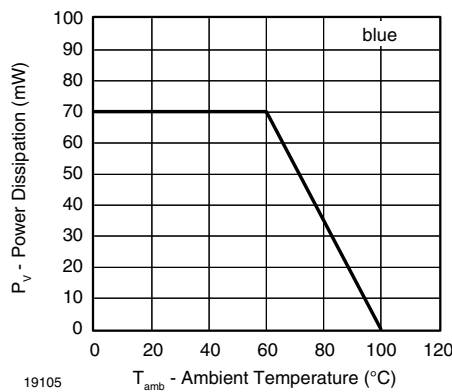

Figure 7. Power Dissipation vs. Ambient Temperature

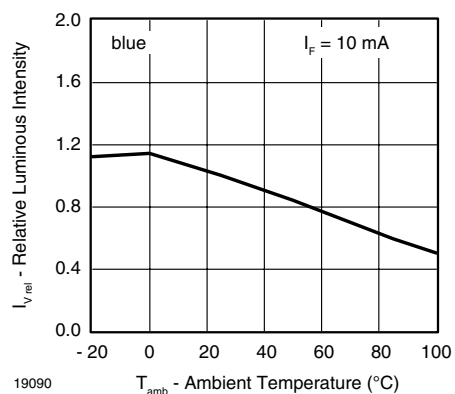

Figure 10. Relative Luminous Intensity vs. Amb. Temperature

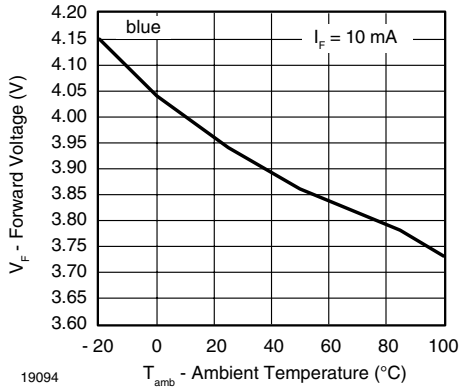

Figure 11. Forward Voltage vs. Ambient Temperature

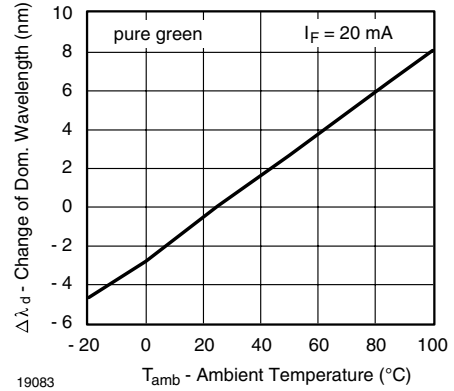

Figure 14. Change of Dominant Wavelength vs. Ambient Temperature

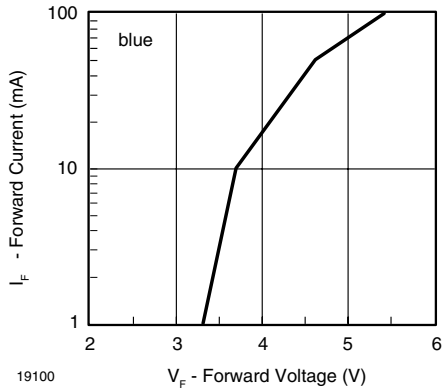

Figure 12. Forward Current vs. Forward Voltage

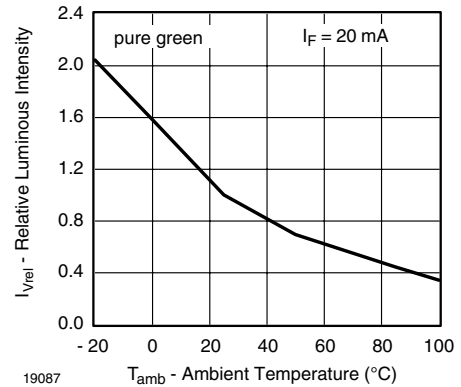

Figure 15. Relative Luminous Intensity vs. Amb. Temperature

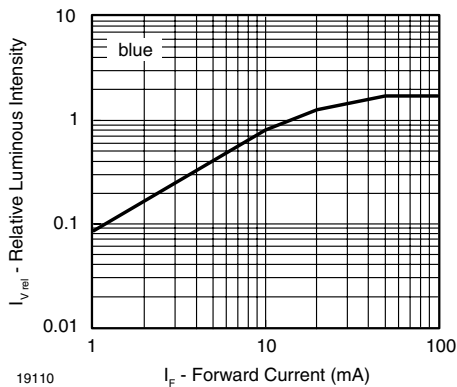

Figure 13. Relative Luminous Intensity vs. Forward Current

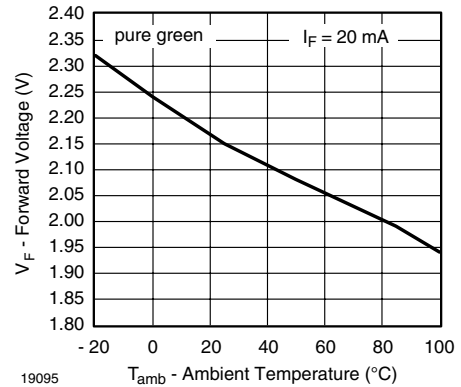

Figure 16. Forward Voltage vs. Ambient Temperature

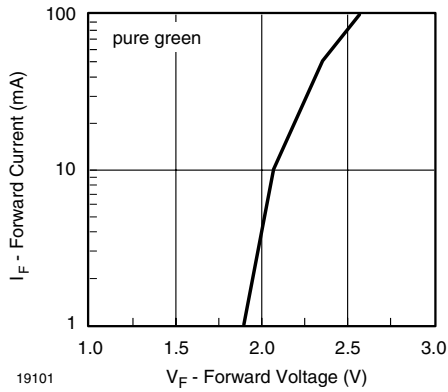

Figure 17. Forward Current vs. Forward Voltage

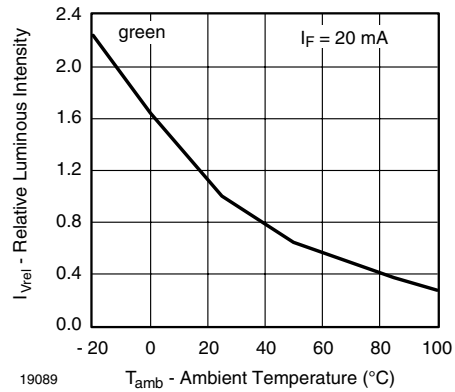

Figure 20. Relative Luminous Intensity vs. Amb. Temperature

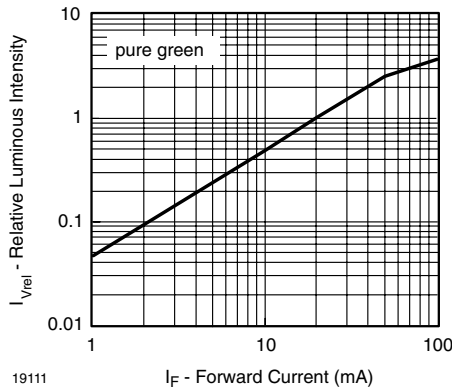

Figure 18. Relative Luminous Intensity vs. Forward Current

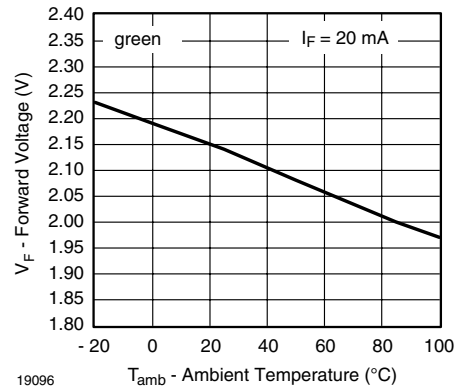

Figure 21. Forward Voltage vs. Ambient Temperature

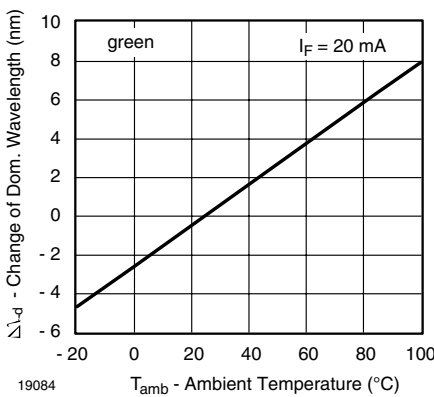

Figure 19. Change of Dominant Wavelength vs. Ambient Temperature

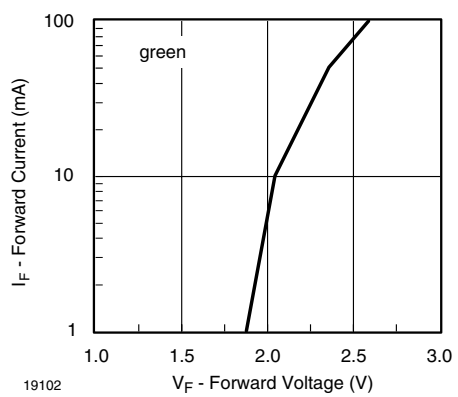

Figure 22. Forward Current vs. Forward Voltage

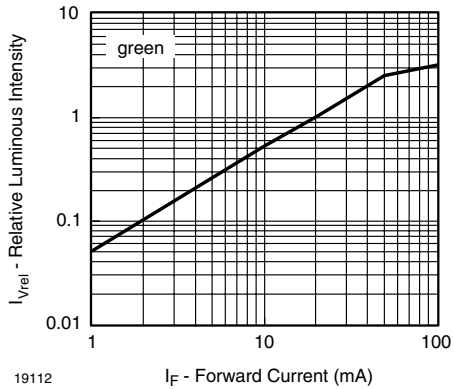

Figure 23. Relative Luminous Intensity vs. Forward Current

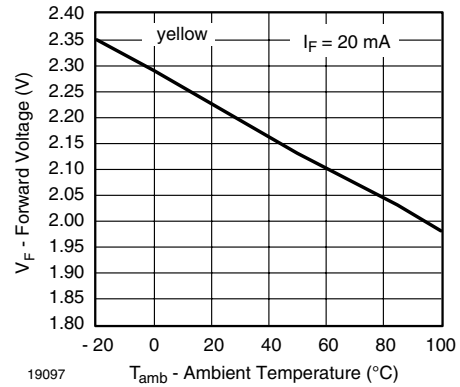

Figure 26. Forward Voltage vs. Ambient Temperature

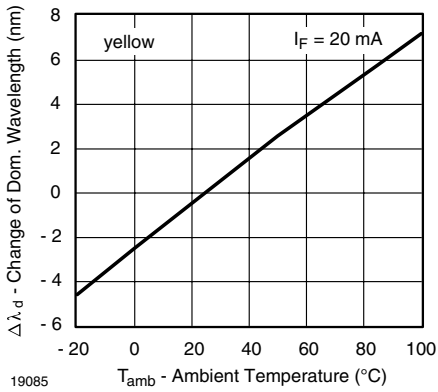

Figure 24. Change of Dominant Wavelength vs. Ambient Temperature

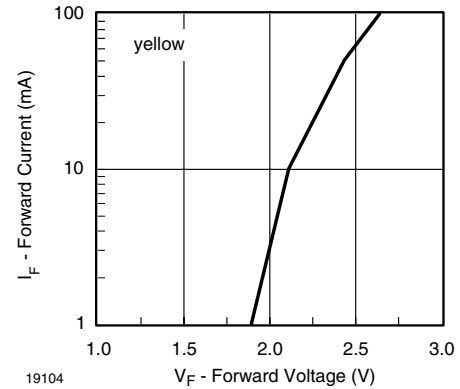

Figure 27. Forward Current vs. Forward Voltage

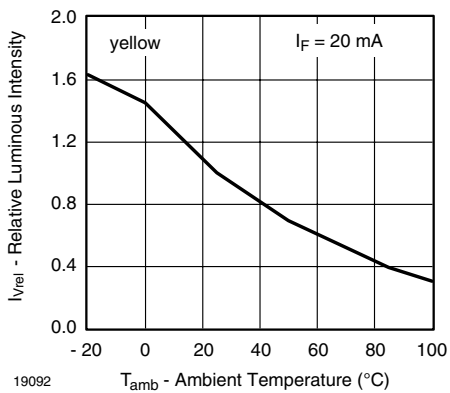

Figure 25. Relative Luminous Intensity vs. Amb. Temperature

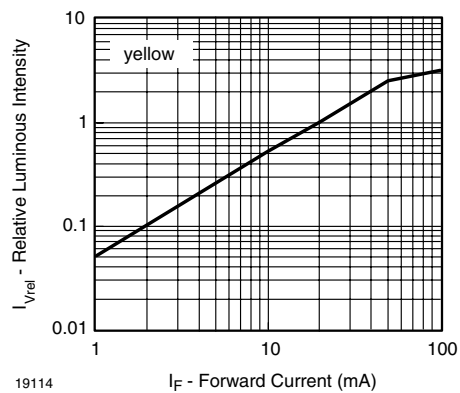

Figure 28. Relative Luminous Intensity vs. Forward Current

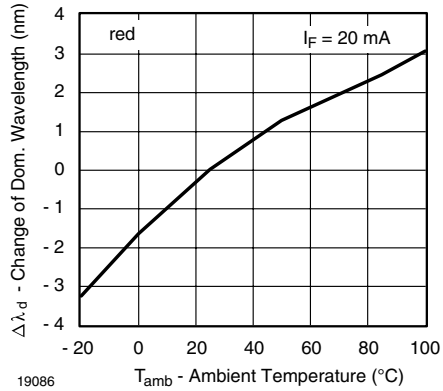

Figure 29. Change of Dominant Wavelength vs. Ambient Temperature

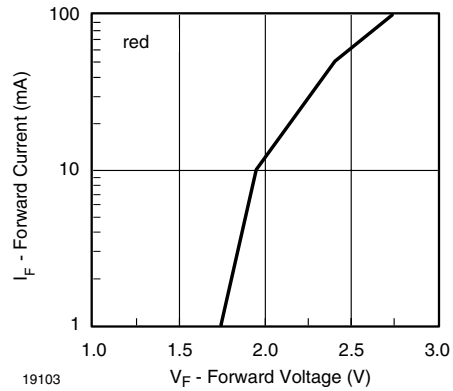

Figure 32. Forward Current vs. Forward Voltage

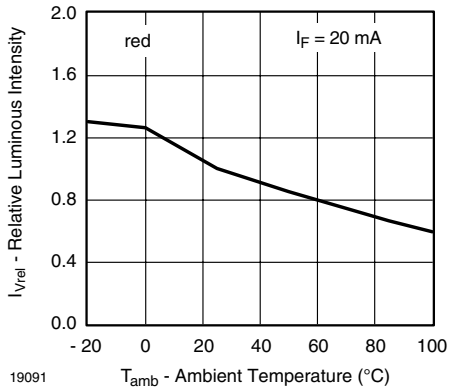

Figure 30. Relative Luminous Intensity vs. Amb. Temperature

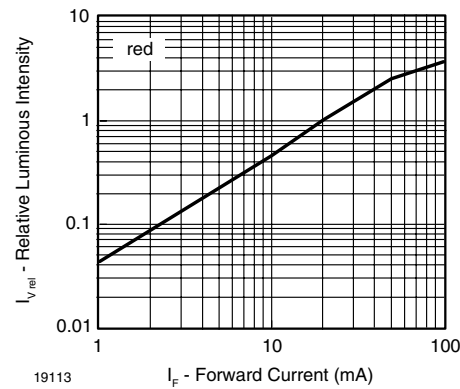

Figure 33. Relative Luminous Intensity vs. Forward Current

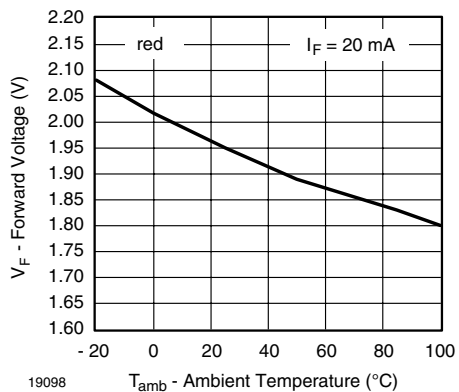
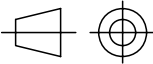
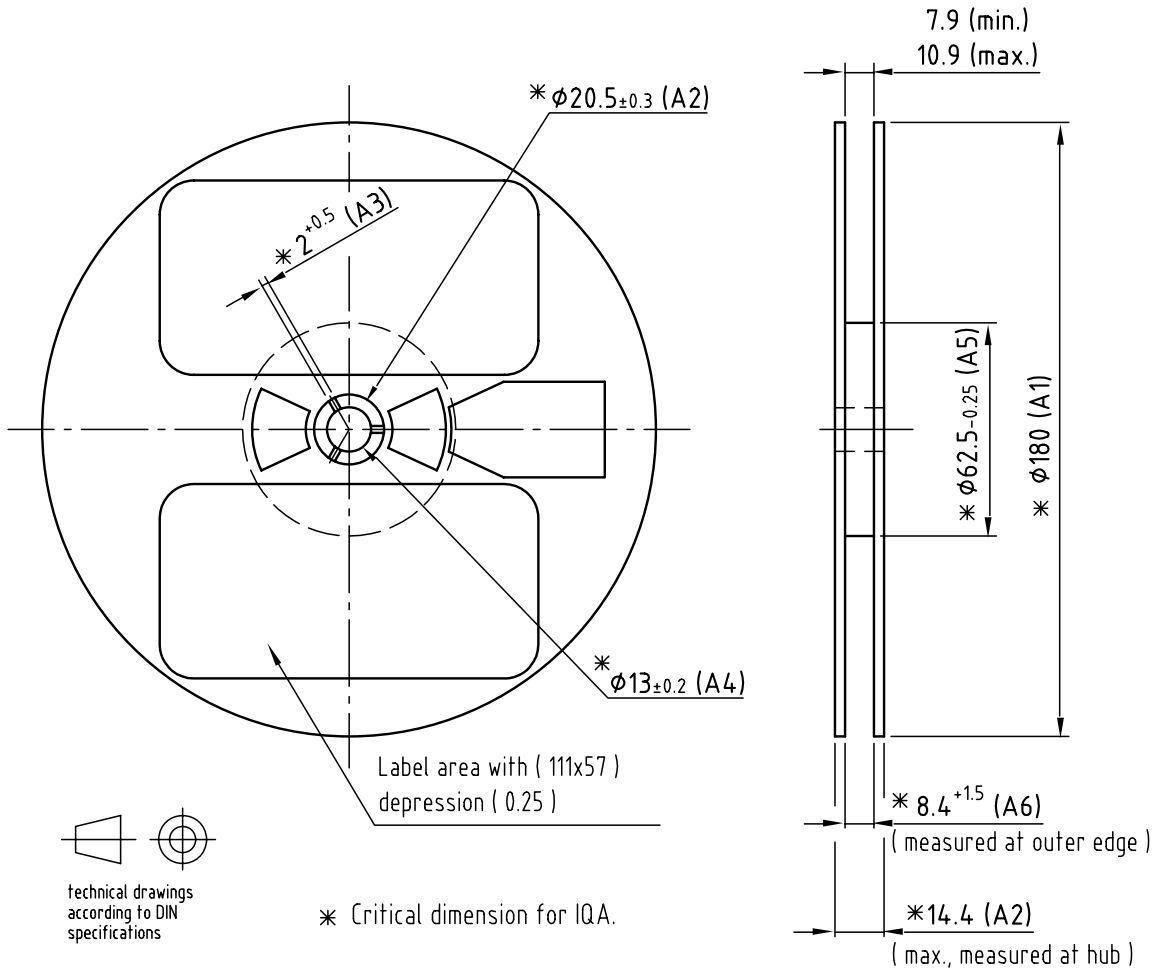

Figure 31. Forward Voltage vs. Ambient Temperature



REEL DIMENSIONS in millimeters



technical drawings according to DIN specifications

Drawing-No.: 9.800-5086.01-4

Issue: 1; 29.04.04

19043

Not indicated tolerances ± 0.05

Material: black static dissipative

TAPE DIMENSIONS in millimeters

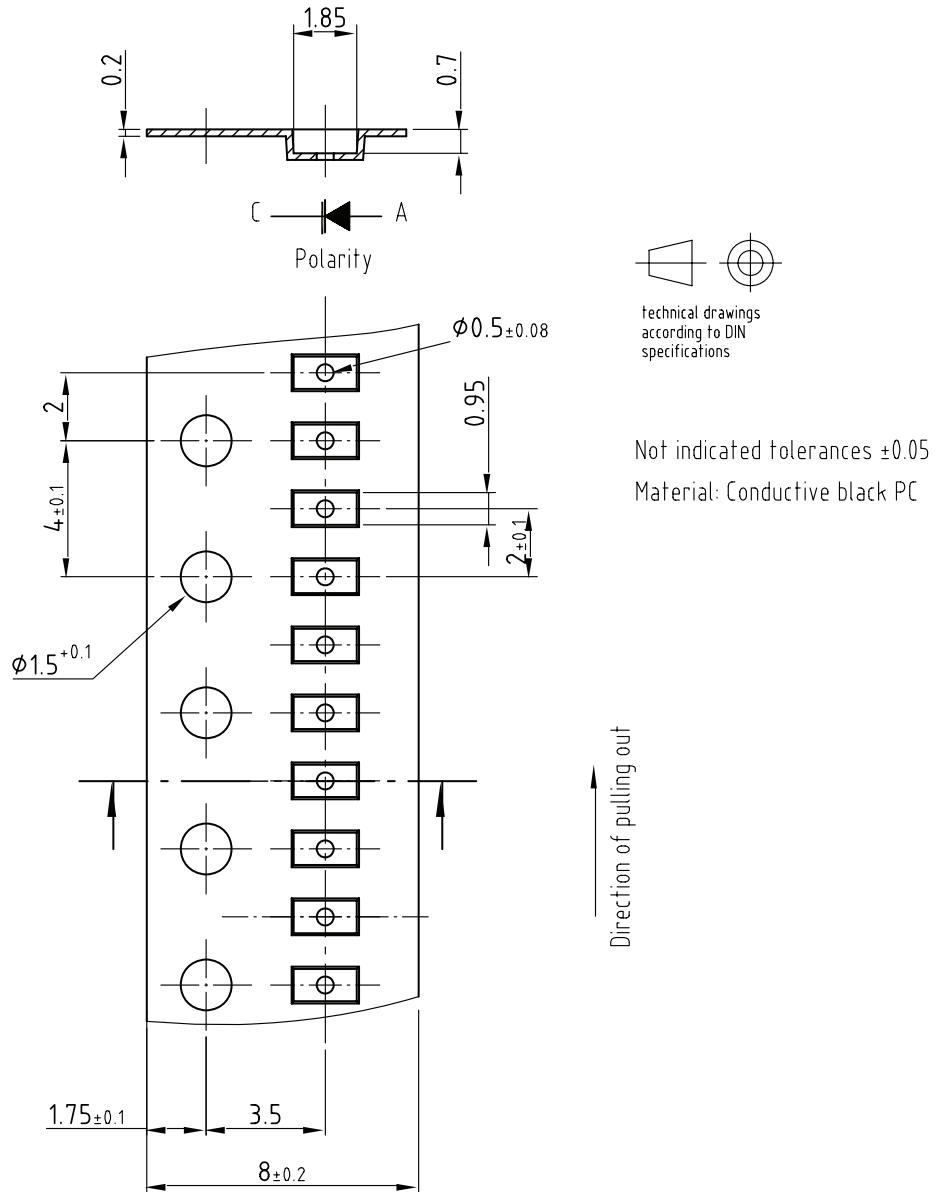

Drawing-No.: 9.700-5290.01-4

Issue: 2; 10.07.06

19044



PACKAGE DIMENSIONS in millimeters

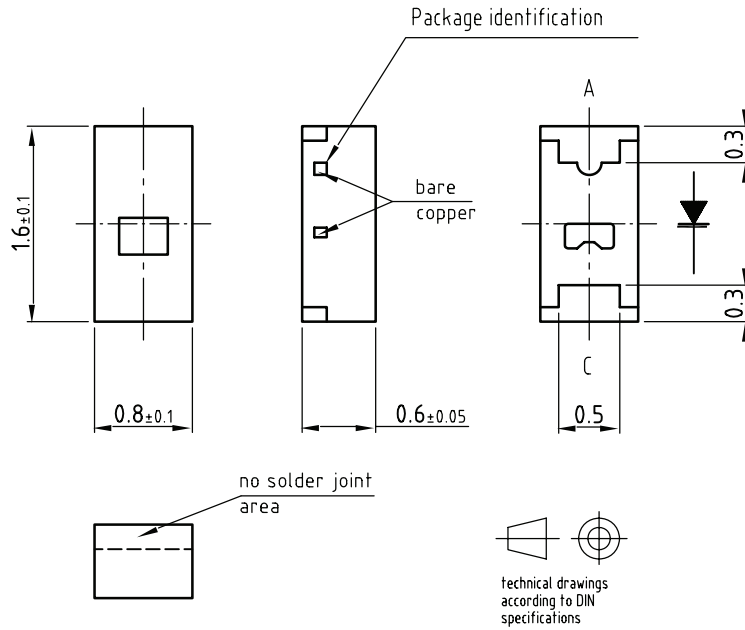

Not indicated tolerances ± 0.1

Recommended solder pad

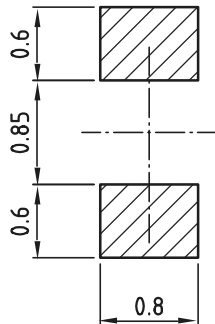

Drawing-No.: 6.541-5056.01-4

Issue: 2; 04.05.05

19426

SOLDERING PROFILE

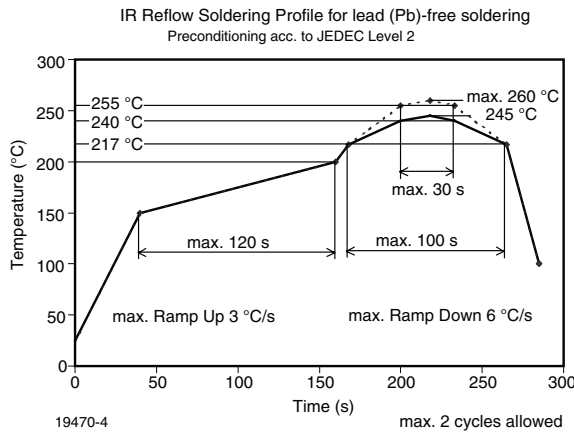
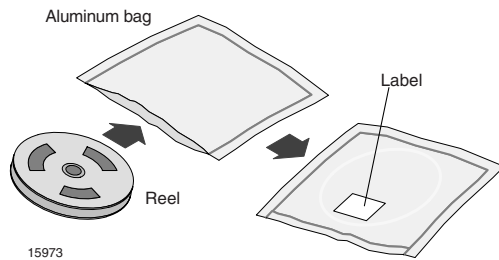

Figure 34. Vishay Lead (Pb)-free Reflow Soldering Profile (acc. to J-STD-020C)

DRY PACKING

The reel is packed in an anti-humidity bag to protect the devices from absorbing moisture during transportation and storage.



FINAL PACKING

The sealed reel is packed into a cardboard box. A secondary cardboard box is used for shipping purposes.

RECOMMENDED METHOD OF STORAGE

Dry box storage is recommended as soon as the aluminum bag has been opened to prevent moisture absorption. The following conditions should be observed, if dry boxes are not available:

- Storage temperature 10 °C to 30 °C
- Storage humidity ≤ 60 % RH max.

After more than 1 year under these conditions moisture content will be too high for reflow soldering.

In case of moisture absorption, the devices will recover to the former condition by drying under the following condition:

192 h at 40 °C + 5 °C/- 0 °C and < 5 % RH (dry air/nitrogen) or

96 h at 60 °C + 5 °C and < 5 % RH for all device containers or

24 h at 100 °C + 5 °C not suitable for reel or tubes.

An EIA JEDEC standard JESD22-A112 level 2 label is included on all dry bags.

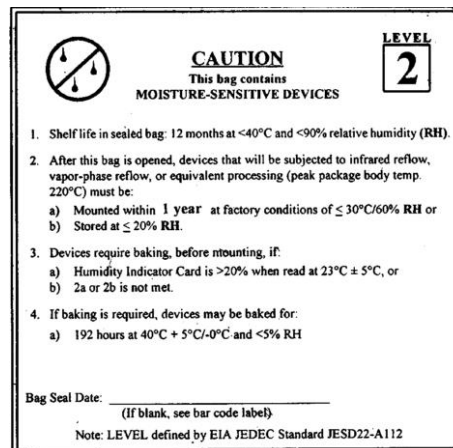

Example of JESD22-A112 level 2 label

ESD PRECAUTION

Proper storage and handling procedures should be followed to prevent ESD damage to the devices especially when they are removed from the antistatic shielding bag. Electro-static sensitive devices warning labels are on the packaging.

VISHAY SEMICONDUCTORS STANDARD BAR CODE LABELS

The Vishay Semiconductors standard bar code labels are printed at final packing areas. The labels are on each packing unit and contain Vishay Semiconductors specific data.



OZONE DEPLETING SUBSTANCES POLICY STATEMENT

It is the policy of Vishay Semiconductor GmbH to

1. Meet all present and future national and international statutory requirements.
2. Regularly and continuously improve the performance of our products, processes, distribution and operating systems with respect to their impact on the health and safety of our employees and the public, as well as their impact on the environment.

It is particular concern to control or eliminate releases of those substances into the atmosphere which are known as ozone depleting substances (ODSs).

The Montreal Protocol (1987) and its London Amendments (1990) intend to severely restrict the use of ODSs and forbid their use within the next ten years. Various national and international initiatives are pressing for an earlier ban on these substances.

Vishay Semiconductor GmbH has been able to use its policy of continuous improvements to eliminate the use of ODSs listed in the following documents.

1. Annex A, B and list of transitional substances of the Montreal Protocol and the London Amendments respectively.
2. Class I and II ozone depleting substances in the Clean Air Act Amendments of 1990 by the Environmental Protection Agency (EPA) in the USA.
3. Council Decision 88/540/EEC and 91/690/EEC Annex A, B and C (transitional substances) respectively.

Vishay Semiconductor GmbH can certify that our semiconductors are not manufactured with ozone depleting substances and do not contain such substances.

We reserve the right to make changes to improve technical design and may do so without further notice.

Parameters can vary in different applications. All operating parameters must be validated for each customer application by the customer. Should the buyer use Vishay Semiconductors products for any unintended or unauthorized application, the buyer shall indemnify Vishay Semiconductors against all claims, costs, damages, and expenses, arising out of, directly or indirectly, any claim of personal damage, injury or death associated with such unintended or unauthorized use.

Vishay Semiconductor GmbH, P.O.B. 3535, D-74025 Heilbronn, Germany



Disclaimer

All product specifications and data are subject to change without notice.

Vishay Intertechnology, Inc., its affiliates, agents, and employees, and all persons acting on its or their behalf (collectively, "Vishay"), disclaim any and all liability for any errors, inaccuracies or incompleteness contained herein or in any other disclosure relating to any product.

Vishay disclaims any and all liability arising out of the use or application of any product described herein or of any information provided herein to the maximum extent permitted by law. The product specifications do not expand or otherwise modify Vishay's terms and conditions of purchase, including but not limited to the warranty expressed therein, which apply to these products.

No license, express or implied, by estoppel or otherwise, to any intellectual property rights is granted by this document or by any conduct of Vishay.

The products shown herein are not designed for use in medical, life-saving, or life-sustaining applications unless otherwise expressly indicated. Customers using or selling Vishay products not expressly indicated for use in such applications do so entirely at their own risk and agree to fully indemnify Vishay for any damages arising or resulting from such use or sale. Please contact authorized Vishay personnel to obtain written terms and conditions regarding products designed for such applications.

Product names and markings noted herein may be trademarks of their respective owners.